

Installation Instructions Industrial fixture

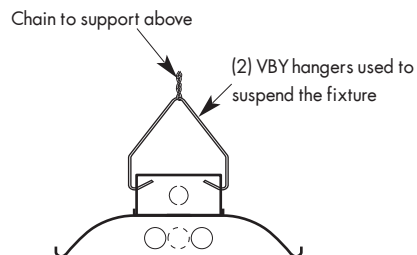

- 1 Each Williams industrial fixture has a center 2" K.O. and 7/8" K.O.'s
- 2 Attach chain onto VBY hanger – attach VBY hanger to the fixture
- 3 Suspend fixture using chain and VBY hanger
- 4 Power can be supplied to the fixture using a 7/8" K.O. on the fixture's back – and bringing a piece of "flex" and connector into the fixture – simply plug the connector through the 7/8" K.O. and make electrical connections in the fixture. The 2" center K.O. can be used when an outlet box is directly above the fixture K.O. for surface mounting

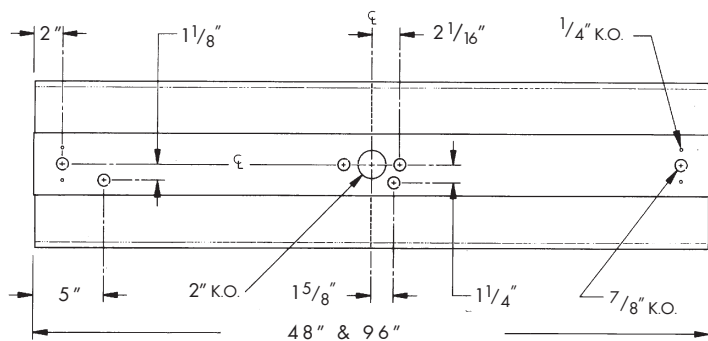

NOTE: 8' fixture uses (2) 4' reflectors
Typical Back Detail

Applicable Fixture Series

Series 80, 81, 82, 83, 84, 85, 88



A Visible Difference

INSTRUCTIONS APPLY TO THE FOLLOWING SERIES:

NOTE: SM75, SM76 END PLATES ARE SPOTWELDED TO CHANNEL
75, 76, 77, 78, 80, 81, 82, 83, 85

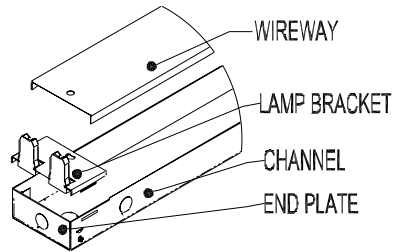

INSTRUCTIONS APPLY TO THE FOLLOWING SERIES:

79, 79A, 79AW, 79W

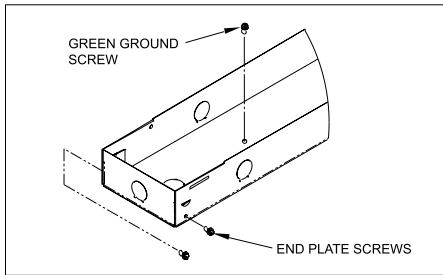
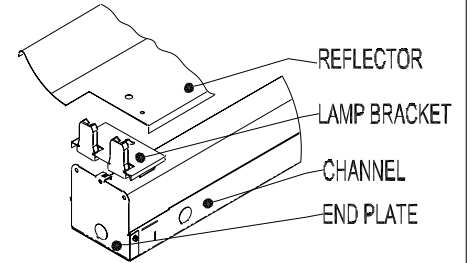

(Step 1) SERIES: 75, 76, 77, 78, 80, 81, 82, 83, 85 INSTRUCTIONS
SNAP-IN END PLATE ONTO CHANNEL AND INSTALL SCREWS ON
END PLATE WITH SNAP-IN OPTION ONLY.

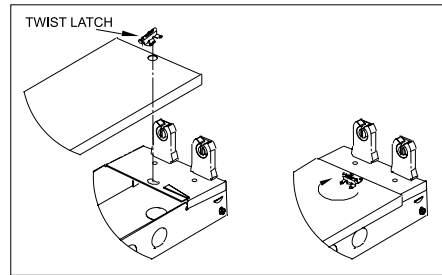

(Step 4) SERIES: 75, 76, 77, 78, 80, 81 INSTRUCTIONS
INSTALL TWIST LATCH INTO WIREWAY AND SECURE ONTO
LAMP BRACKET.

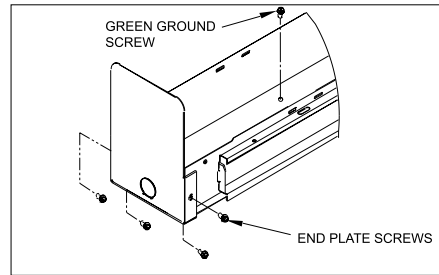

(Step 1) SERIES: 79W, 79AW INSTRUCTIONS
POSITION END PLATE ONTO CHANNEL AND INSTALL SCREWS.

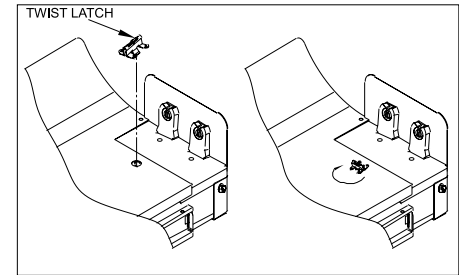

(Step 4) SERIES: 79W, 79AW INSTRUCTIONS
INSTALL TWIST LATCH INTO REFLECTOR AND SECURE ONTO
LAMP BRACKET.

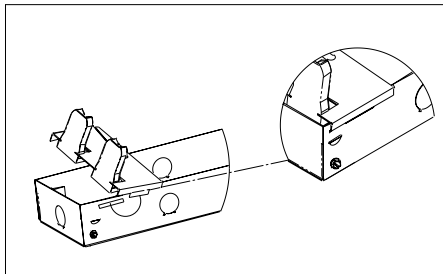

(Step 2) ALIGN ANGLED FLANGE IN LAMP BRACKET WITH SLOT IN
CHANNEL. SLIGHTLY SQUEEZE CHANNEL SIDES; HINGE LAMP
BRACKET OVER CHANNEL.

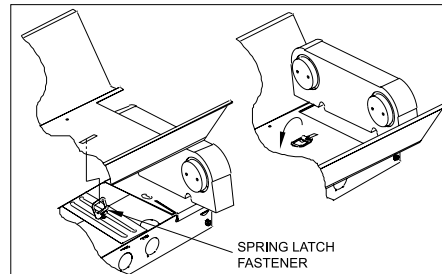

(Step 5) SERIES: 82 AND 83 INSTRUCTIONS
ALIGN SPRING LATCH FASTENERS WITH SLOT IN REFLECTOR.
PULL SPRING LATCH UPWARD AND ROTATE 1/4 TURN. FOLD
SPRING LATCH DOWN.

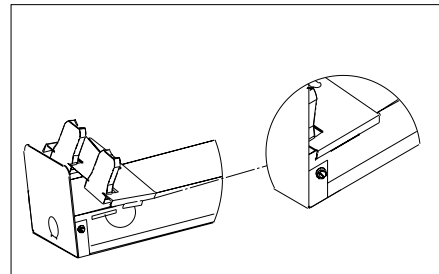

(Step 2) ALIGN ANGLED FLANGE IN LAMP BRACKET WITH SLOT IN
CHANNEL. SLIGHTLY SQUEEZE CHANNEL SIDES; HINGE LAMP
BRACKET OVER CHANNEL.

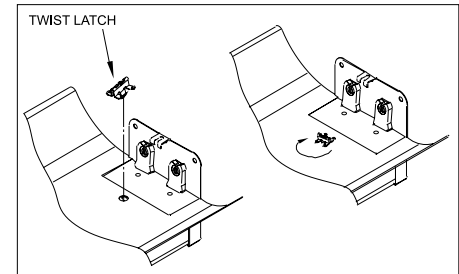

(Step 5) SERIES: 79A INSTRUCTIONS
INSTALL TWIST LATCH INTO REFLECTOR AND SECURE ONTO
LAMP BRACKET.

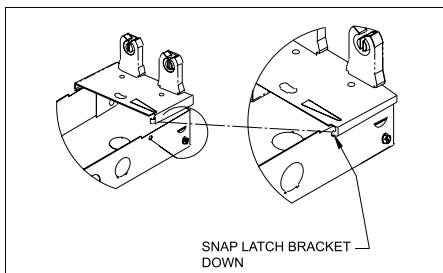

(Step 3) ON OTHER SIDE OF CHANNEL, ALIGN PROTRUDING TAB
WITH HOLE IN CHANNEL.

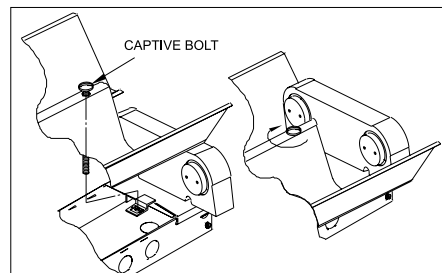

(Step 6) SERIES: 85 INSTRUCTIONS
ALIGN REFLECTOR AND CAPTIVE BOLT ONTO LAMP BRACKET.
SECURELY FASTEN TO LAMP BRACKET.

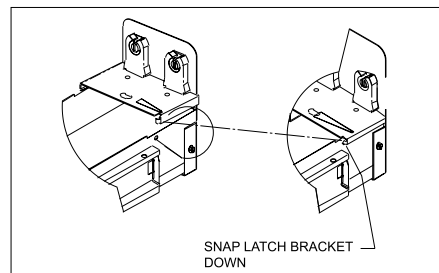

(Step 3) ON OTHER SIDE OF CHANNEL, ALIGN PROTRUDING TAB
WITH HOLE IN CHANNEL.

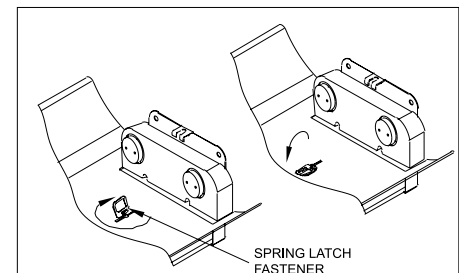

(Step 6) SERIES: 79 INSTRUCTIONS
ALIGN SPRING LATCH FASTENER WITH SLOT IN REFLECTOR. PULL
SPRING LATCH UPWARD AND ROTATE 1/4 TURN. FOLD SPRING
LATCH DOWN.

Instructions for Continuous Row Mounting of 74 Series Strips

1. Insert tabs into slots of adjoining fixtures and bend tabs up 90° to lock fixtures together.

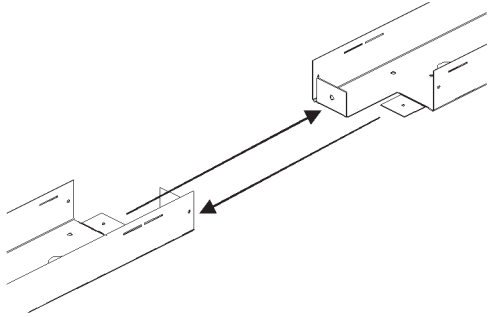

2. Secure tabs via screws into the holes on the tabs connecting the fixtures.

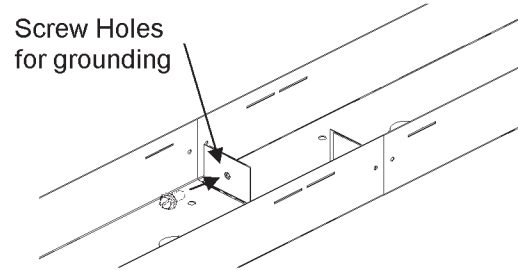

3. Install end plate on each fixture at row ends. Insert screws into holes on side of end plates to secure to the fixture.

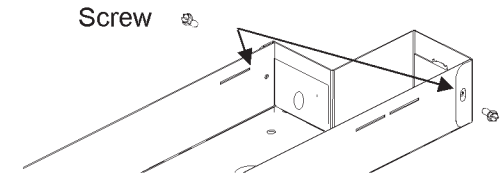

Note: If power supply enters fixture through end plate remove continuous row tab from channel by breaking it off before installing end plate.

4. Install lamp brackets. Insert tabs into the appropriate slots on each side of the housing.

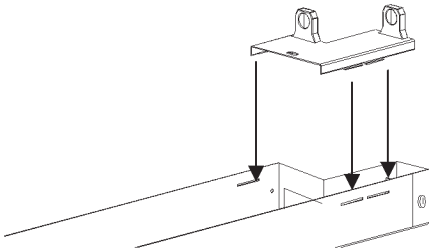

5. Place wireway cover onto fixture. Secure via twist latch.

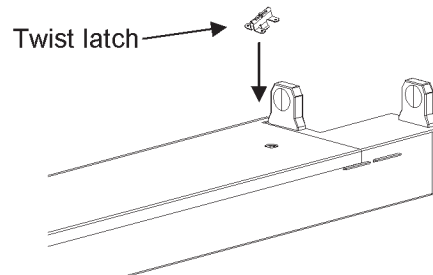

6. Install lamps once all other steps have been completed.

