

DECORATIVE LUMINAIRE

OGL

SUBMITTAL:

JOB:

TYPE:

VOLTAGE:

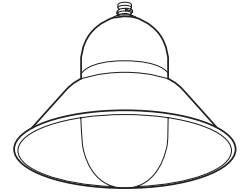

EXAMPLE:

OGL - 150PSMH120 - A206 - DBR - OPTIONS

SERIES

ELECTRICAL PACKAGE

HOOD

FINISH OPTIONS

OPTIONS

SERIES

OGL — The OGL Series features a bullet style diffuser and our exclusive twist-lock fitter for easy field installation. Mix and match assorted hood styles to achieve desired results.

MOUNTING — Williams' exclusive self-leveling twist-lock fitter must be mounted to Williams' standard (TL2) twist-lock hub (see Williams' Decorative Pole Top Assemblies).

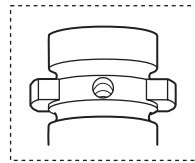

DETAIL
Standard Twist-lock Fitter (Fits TL2 Hub)

This fixture is proudly made in the USA.

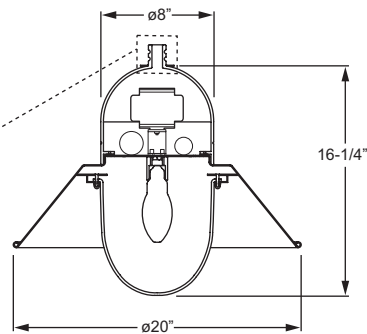

OGL with A206 Hood

OGL SERIES

HOUSING — One-piece cast aluminum ballast housing, .188" minimum wall thickness, with exclusive self-leveling twist-lock fitter.

DIFFUSER — One-piece bullet-shaped U.V. stabilized opal acrylic.

ELECTRICAL PACKAGE (Must specify)

PULSE START METAL HALIDE

Lamp:	ED-17/E17	ED-17/E17
Socket:	E26 Medium	E26 Medium
ANSI Ballast Code:	M90/M140	M102/M142

100PSMH120	150PSMH120
100PSMH208	150PSMH208
100PSMH240	150PSMH240
100PSMH277	150PSMH277
100PSMH347	150PSMH347
100PSMH480	150PSMH480

HIGH PRESSURE SODIUM

Lamp:	E17	E17
Socket:	E26 Medium	E26 Medium
ANSI Ballast Code:	S54	S55

100HPS120	150HPS120
100HPS208	150HPS208
100HPS240	150HPS240
100HPS277	150HPS277
100HPS347	150HPS347
100HPS480	150HPS480

ELECTRICAL PACKAGE

PSMH — Rated -20°F minimum starting temperature.

HPS — Rated -40°F minimum starting temperature.

All PSMH and HPS electrical packages include porcelain socket. Core and coil ballast mounted on removable ballast tray. Prewired at factory to a disconnect plug for easy field installation. HX-HPF or CWA ballast type standard. Lamp is optional, please specify when ordering.



HOOD

Spun aluminum reflector hood in various styles and sizes, minimum .080" wall thickness. Underside finish is highly reflective, non-glare white polyester powder coat.

HOOD (Must specify)

ANGLED HOOD

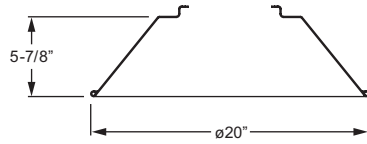

A206 20" x 6" angled hood
Total fixture EPA: .84/Weight: 22 Lbs.

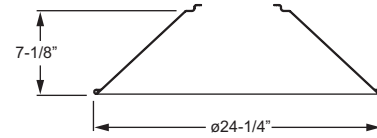

A247 24" x 7" angled hood
Total fixture EPA: .95/Weight: 23 Lbs.

CURVED HOOD

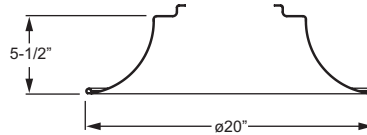

C205 20" x 5" curved hood
Total fixture EPA: .83/Weight: 22 Lbs.

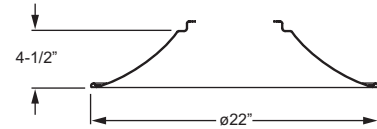

C225 22" x 5" curved hood
Total fixture EPA: .80/Weight: 22 Lbs.

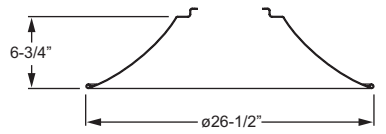

C267 26" x 7" curved hood
Total fixture EPA: .94/Weight: 24 Lbs.

ROUND HOOD

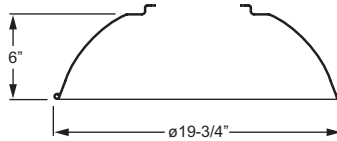

R206 20" x 6" round hood
Total fixture EPA: .88/Weight: 22 Lbs.

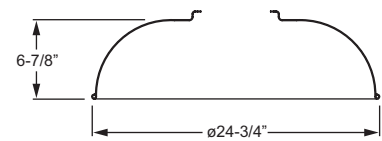

R247 24" x 7" round hood
Total fixture EPA: 1.10/Weight: 24 Lbs.

FINISH OPTIONS

Super durable polyester powder coat meets and exceeds AAMA 2604 specifications for outdoor durability.

FINISH OPTIONS (Must specify)

BLK	Black (RAL #9004)	DBR	Dark bronze (Protech #PC21462)
GRAY	Standard gray (Protech #PC18367)	GRN	Green (RAL #6005)
SLV	Satin aluminum (RAL #9006)	WHT	White (RAL #9003)
RAL#	Specify custom color		

OPTIONS

SF	Single fuse (120V, 277V, or 347V only; must specify voltage)	DF	Double fuse (208V, 240V, or 480V only; must specify voltage)
-----------	--	-----------	--

DISTRIBUTION

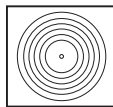

Type V

LABELS

cCSAus certified as luminaire suitable for wet locations.