

DECORATIVE NON-TAPERED ALUMINUM POLE AND BASE

AV20

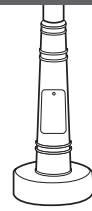

SUBMITTAL:

JOB:

TYPE:

EXAMPLE:

VM - AV20 - A - 080 - 40 - 188 - S - T238 - DBR - AB - OPTIONS

PREFIX SERIES MATERIAL HEIGHT TOP DIAMETER WALL THICKNESS SHAFT STYLE FIXTURE MOUNTING FINISH OPTIONS ANCHOR BOLTS OPTIONS/ ACCESSORIES

SERIES

AV20 — Series AV20 poles are 8' to 16' in height including a cast aluminum structural base and a 4" O.D. straight round aluminum shaft. The pole is designed to accommodate up to two fixtures on a pole top assembly with a maximum 36" O.C. fixture span.

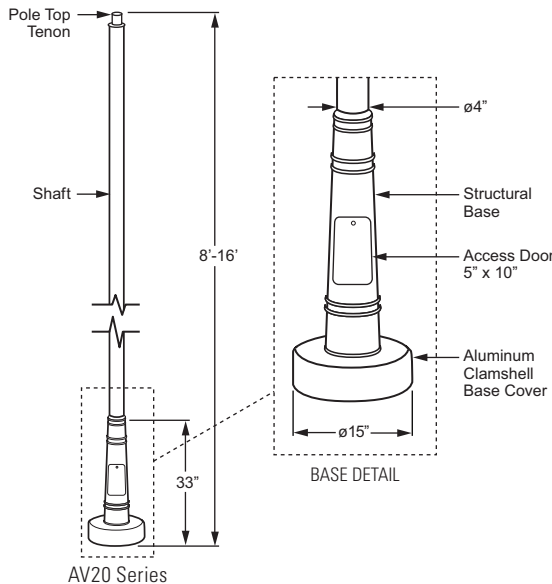

AV20 SERIES

SHAFT — The pole shaft is extruded from seamless 6063 alloy aluminum.

POLE TOP — A pole top plate and tenon (must specify size) are provided for top mount luminaire or Williams' pole top assembly. A removable finial is available for poles receiving drilling patterns for side-mount luminaire arm assemblies.

ACCESS DOOR

The structural base includes an access door for easy on-site maintenance.

STRUCTURAL BASE

The structural base is cast from 356 alloy aluminum. A grounding provision with hardware is provided. The pole is inserted and welded into the structural base casting. The completed assembly is heat-treated to T6 temper.

BASE COVER

A clamshell base cover is cast from high quality aluminum.

MATERIAL (Must specify)

A Aluminum

HEIGHT (Must specify)

080	8'-0"	100	10'-0"	120	12'-0"
140	14'-0"	160	16'-0"	SL_ ___	Special Pole Length (Please specify, consult factory)

TOP DIAMETER (Must specify)

40 4"

WALL THICKNESS (Must specify)

188 0.188" **250** 0.250" (14' and 16' shaft heights only)

SHAFT STYLE (Must specify)

S Straight Round

FIXTURE MOUNTING

Designed for pole top tenon or drilled side mount. See Williams' Pole Top Assemblies for various fixture mounting tenon and arm assemblies.

RADIAL INDEX

The Radial Index references how parts are oriented around the shaft. A degree measurement is used from a base point. The standard base point of reference is the access door. Degrees are measured in a clockwise motion as viewed from the top of the shaft.

FIXTURE MOUNTING (Must specify)

POLE TOP MOUNT

T238	2-3/8" O.D. x 4" Round Tenon
T278	2-7/8" O.D. x 4" Round Tenon
T33	3" O.D. x 3" Round Tenon (Use with Williams' Historic Pole Top Assemblies)
T312	3-1/2" O.D. x 12" Round Tenon (Use with Williams' AVPT Decorative Pole Top Assemblies)
TC____	Custom Round Tenon (Must specify tenon diameter (O.D.) and height, consult factory)

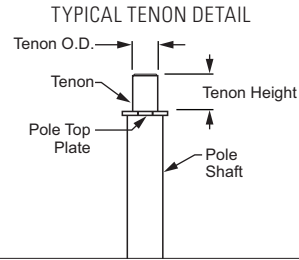

DRILLED SIDE MOUNT

Must specify drilling location using codes below. See radial index for clarification.

EXAMPLE: sm/s
(Side mount drill, single fixture located at 0°)

RADIAL INDEX

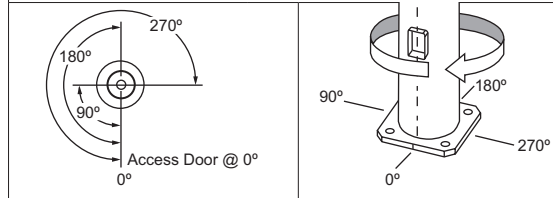

SM/S

Side Mount Drill/Single 0°
(Located at 0°)



SM/D90

Side Mount Drill/Double 90°
(Located at 0° and 90°)



SM/D180

Side Mount Drill/Double 180°
(Located at 0° and 180°)



SM/T90

Side Mount Drill/Triple 90°
(Located at 0°, 90°, and 180°)



SM/T120

Side Mount Drill/Triple 120°
(Located at 0°, 120°, and 240°)

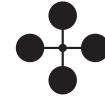

SM/Q90

Side Mount Drill/Quad 90°
(Located at 0°, 90°, 180°, and 270°)

FINISH OPTIONS

Polyester powder coat applied over chromate pre-treatment.

FINISH OPTIONS (Must specify)

BLK	Black (RAL# 9004)	DBR	Dark Bronze (Protech #PC21462)
GRAY	Standard Gray (Protech #PC18367)	GRN	Green (RAL# 6005)
SLV	Satin Aluminum (RAL# 9006)	WHT	White (RAL# 9003)
RAL#____	Specify Custom Color		

ANCHOR BOLTS

Anchor bolts conform to ASTM F1554 Grade 55 and are provided with two hex nuts and two flat washers. Bolts have an "L" bend on one end and are galvanized a minimum of 12" on the threaded end. Template provided with every pole and anchor bolt order.

ANCHOR BOLTS (Must specify)

AB	Anchor bolts (4 each, shipped with pole)
LAB	Less anchor bolts
PAB	Pre-shipped Anchor Bolts (4 each)

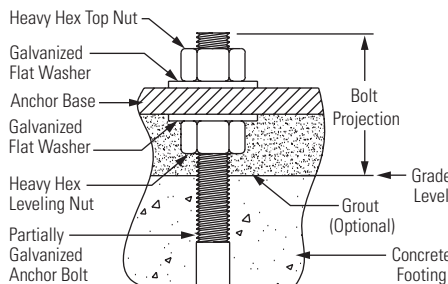

BOLT PROJECTION DETAIL

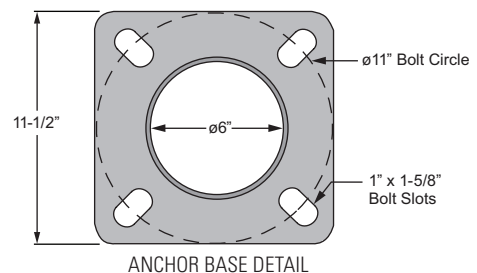

ANCHOR BASE DETAIL

STRUCTURAL BASE				ANCHOR BOLTS		
BOLT CIRCLE		SQ. (IN)	THK. (IN)	BOLT SIZE (IN)	PROJECTION (IN)	± (IN)
DIA. (IN)	± (IN)					
11.00	N/A	11.50	0.75	0.75 x 17.00 x 3.00	3.25	N/A

OPTIONS

FS Festoon Box only

NOTE: Casting only. Outlet, cover and hardware by others. The festoon box is located above the access door at 0°.

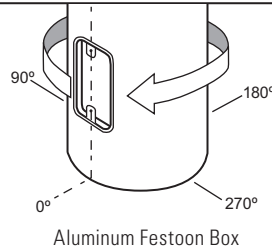

ACCESSORIES

FINIALS (For poles with side-mount drill only, for additional finial options consult factory)



B Ball



H South River



M Metro



N Pineapple



P Point



R Pantheon



S Spear



V Burnsville

LOAD AND DIMENSIONAL DATA

POLE HT. (FT)	CATALOG NUMBER	POLE DIMENSIONS				80 MPH ^{1,2}		90 MPH ^{1,2}		100 MPH ^{1,2}	
		BASE O.D. (IN)	TOP O.D. (IN)	WALL THK. (IN)	STRUC. WT. ³ (LBS)	MAX LUMINAIRE EPA (SQ FT)	MAX LUMINAIRE WEIGHT (LBS)	MAX LUMINAIRE EPA (SQ FT)	MAX LUMINAIRE WEIGHT (LBS)	MAX LUMINAIRE EPA (SQ FT)	MAX LUMINAIRE WEIGHT (LBS)
8	AV20-A-080-40-188-S	4	4	.188	45	16.4	65	12.8	65	10.3	65
10	AV20-A-100-40-188-S	4	4	.188	50	13.3	65	10.3	65	8.3	65
12	AV20-A-120-40-188-S	4	4	.188	56	10.9	65	8.4	65	6.6	65
14	AV20-A-140-40-188-S	4	4	.188	61	9.0	65	6.8	65	5.3	65
14	AV20-A-140-40-250-S	4	4	.250	70	11.9	65	9.1	65	7.1	65
16	AV20-A-160-40-188-S	4	4	.188	66	7.2	65	5.3	65	4.0	65
16	AV20-A-160-40-250-S	4	4	.250	77	9.7	65	7.3	65	5.6	65

¹ Effective Projected Area (EPA) calculations allow for 1.3 Wind Gust Factor. Maximum EPA and weight values are based on top mounted luminaires or arm assembly having a centroid 3'-0" above and 3'-0" eccentric to the pole top at Nominal Mounting Height. Variations from sizes above are available upon inquiry. Satisfactory performance of poles is dependent upon the pole being properly attached to a supporting foundation of adequate design. See Williams Outdoor Information Section, page 6, for Load and Dimensional Data specifics.

² Wind map provided in Williams Outdoor information section, pole information page 6.

³ Structure Weight is a nominal value which includes the pole shaft and structural base.

* Pole installations in various parts of the country perform satisfactorily; however, in select locations destructive vibration can occur. H.E. Williams, Inc. is not responsible for vibration induced fatigue damage.

* H.E. Williams, Inc. warrants this product to be free from defects in materials and workmanship. Any defective part returned within one year from the date of delivery of the goods will be repaired or replaced without charge, F.O.B. factory.

This warranty specifically excludes fatigue or similar phenomena resulting from induced vibration, harmonic oscillation or resonance associated with movement of air currents around the product.

The above warranties are given in lieu of all other warranties express or implied, including without limitation, the warranty of merchantability and the warranty of suitability for a particular purpose. It is expressly stated that H.E. Williams, Inc. assumes no liability for consequential or liquidated damages arising out of a breach of the sale, including any warranties arising therefrom, and buyer's remedy shall be limited to repair or replacement of defective parts as described above.

Any action for the breach under a sale including any warranties arising therefrom must be commenced within one year after the cause of action accrues.

AV20

DECORATIVE NON-TAPERED ALUMINUM POLE AND BASE

