

24" ROUND HOOD LUMINAIRE

OCR24



SUBMITTAL:

JOB:

TYPE:

VOLTAGE:

EXAMPLE: **OCR24 - 150PSMH120 - OBL - DBR - OPTIONS**

SERIES

ELECTRICAL PACKAGE

OPTICAL PACKAGE

FINISH OPTIONS

OPTIONS

SERIES

OCR24 — A full 24" diameter round hood is the outstanding feature of the OCR24. Available with pulse start metal halide or high pressure sodium lamp options and three different optical packages, the OCR24 offers multiple solutions for a variety of outdoor lighting applications.

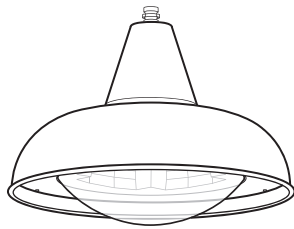

Shown with Clear Drop Polycarbonate Lens
Total fixture EPA: 1.31/Weight: 30 Lbs.

This fixture is proudly made in the USA.

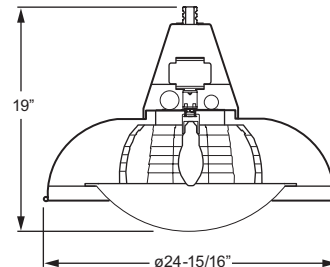

CROSS-SECTION

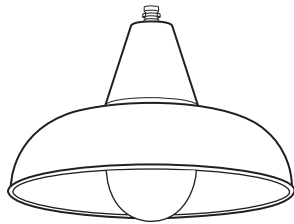

Shown with Opal Bullet Lens
Total fixture EPA: 1.17/Weight: 25 Lbs.

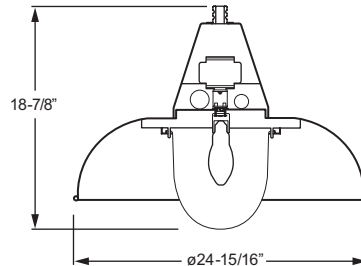

CROSS-SECTION

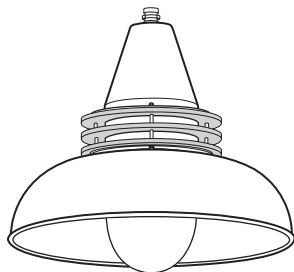

Shown with Opal Bullet Lens and Glow Rings
Total fixture EPA: 1.54/Weight: 31 Lbs.

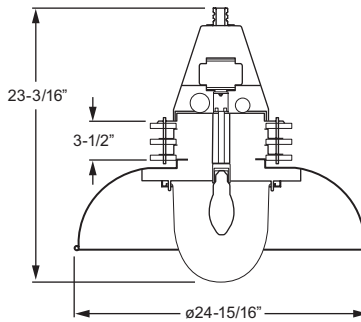

CROSS-SECTION

OCR24 SERIES

HOUSING — One-piece cast aluminum ballast housing, .188" minimum wall thickness, with exclusive self-leveling twist-lock fitter.

HOOD — Spun aluminum reflector hood, minimum .080" wall thickness. Underside finish is highly reflective white polyester powder coat.

ELECTRICAL PACKAGE

PSMH — Rated -20°F minimum starting temperature.

HPS — Rated -40°F minimum starting temperature.

All PSMH and HPS electrical packages include porcelain socket. Core and coil ballast mounted on removable ballast tray. Prewired at factory to a disconnect plug for easy field installation. HX-HPF or CWA ballast type standard. Lamp is optional, please specify when ordering.

ELECTRICAL PACKAGE (Must specify)

PULSE START METAL HALIDE

Lamp:	ED-17/E17	ED-17/E17
Socket:	E26 Medium	E26 Medium
ANSI Ballast Code:	M90/M140	M102/M142

HIGH PRESSURE SODIUM

E17	E17
E26 Medium	E26 Medium
S54	S55

	100PSMH120	150PSMH120	100HPS120	150HPS120
	100PSMH208	150PSMH208	100HPS208	150HPS208
	100PSMH240	150PSMH240	100HPS240	150HPS240
	100PSMH277	150PSMH277	100HPS277	150HPS277
	100PSMH347	150PSMH347	100HPS347	150HPS347
	100PSMH480	150PSMH480	100HPS480	150HPS480



OPTICAL PACKAGE

CLEAR DROP POLYCARBONATE LENS

Molded clear U.V. stabilized polycarbonate drop lens, sealed with a closed-cell neoprene gasket. Segmented, highly specular reflector in a high-reflectance white frame.

OPAL BULLET LENS

One-piece bullet-shaped U.V. stabilized opal acrylic lens.

OPAL BULLET LENS AND GLOW RINGS

One-piece bullet-shaped U.V. stabilized opal acrylic lens. Three evenly-spaced, edge-lit, U.V. stabilized, .375" thick, transparent heat-resistant acrylic rings.

OPTICAL PACKAGE (Must specify)

CLEAR DROP POLYCARBONATE LENS

DPL Clear drop polycarbonate lens

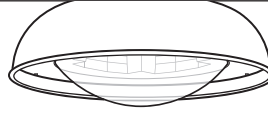

OPAL BULLET LENS

OBL Opal bullet lens

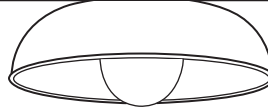

OPAL BULLET LENS AND GLOW RINGS

OBR/AM Opal bullet lens and amber glow rings

OBR/BL Opal bullet lens and blue glow rings

OBR/CL Opal bullet lens and clear glow rings

OBR/GR Opal bullet lens and green glow rings

OBR/RED Opal bullet lens and red glow rings

OBR/SLG Opal bullet lens and soda lime green glow rings

OBR/YL Opal bullet lens and yellow glow rings

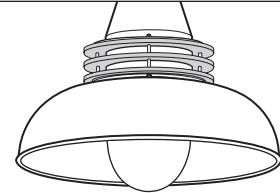

FINISH OPTIONS (Must specify)

BLK Black (RAL #9004)

DBR Dark bronze (Protech #PC21462)

GRAY Standard gray (Protech #PC18367)

GRN Green (RAL #6005)

SLV Satin aluminum (RAL #9006)

WHT White (RAL #9003)

RAL# Specify custom color

FINISH OPTIONS

Super durable polyester powder coat meets and exceeds AAMA 2604 specifications for outdoor durability.

MOUNTING

Williams' exclusive self-leveling twist-lock fitter must be mounted to Williams' standard (TL2) twist-lock hub (see Williams' Decorative Pole Top Assemblies).



STANDARD TWIST-LOCK FITTER (Fits TL2 hub)

OPTIONS

SF Single fuse (120V, 277V, or 347V only; must specify voltage)

DF Double fuse (208V, 240V, or 480V only; must specify voltage)

DISTRIBUTION

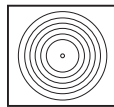

Type V

LABELS

cCSAus certified as luminaire suitable for wet locations.

