

20" CURVED HOOD LUMINAIRE WITH WINDOW

OCC20W

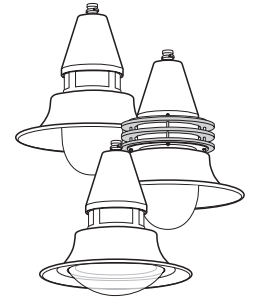

SUBMITTAL:

JOB:

TYPE:

VOLTAGE:

EXAMPLE: **OCC20W - 150PSMH120 - OBL - DBR - OPTIONS**

SERIES

ELECTRICAL PACKAGE

OPTICAL PACKAGE

FINISH OPTIONS

OPTIONS

SERIES

OCC20W — A decorative window below the cone-shaped ballast housing adds a subtle uplight option to the OCC20W Series. A curved hood, various optical packages, and our exclusive self-leveling twist-lock fitter are some outstanding features of the OCC20W.

This fixture is proudly made in the USA.

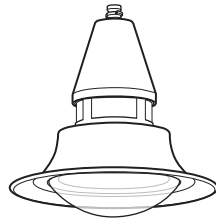

Shown with Clear Drop Polycarbonate Lens
Total fixture EPA: .90/Weight: 29 Lbs.

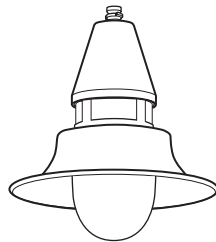
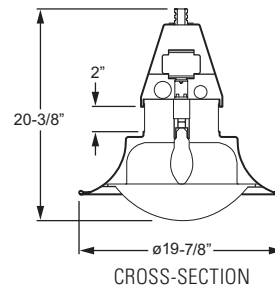

Shown with Opal Bullet Lens
Total fixture EPA: 1.00/Weight: 24 Lbs.

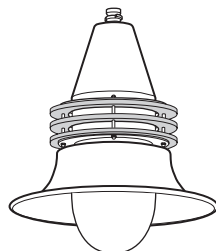
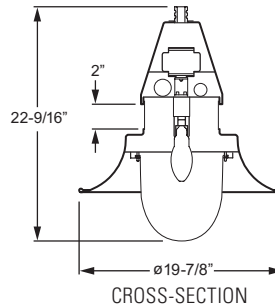

Shown with Opal Bullet Lens and Polished Aluminum Rings
Total fixture EPA: 1.14/Weight: 30 Lbs.

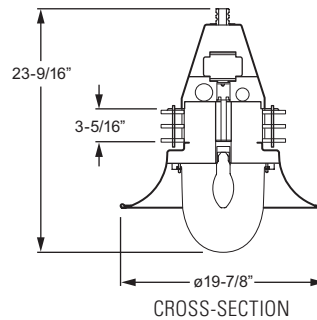

OCC20W SERIES

HOUSING — One-piece cast aluminum ballast housing, .188" minimum wall thickness, with exclusive self-leveling twist-lock fitter.
UPPER DIFFUSER — Opal acrylic window, .188" thick, with silicone seal.
HOOD — Spun aluminum reflector hood, minimum .080" wall thickness. Underside finish is highly reflective white polyester powder coat.

ELECTRICAL PACKAGE

PSMH — Rated -20°F minimum starting temperature.
HPS — Rated -40°F minimum starting temperature.

All PSMH and HPS electrical packages include porcelain socket. Core and coil ballast mounted on ballast tray. Prewired at factory to a disconnect plug for easy field installation. OBR optical package includes removable ballast tray. HX-HPF or CWA ballast type standard. Lamp is optional, please specify when ordering.

ELECTRICAL PACKAGE (Must specify)

PULSE START METAL HALIDE

| | | |
|--------------------|------------|------------|
| Lamp: | ED-17/E17 | ED-17/E17 |
| Socket: | E26 Medium | E26 Medium |
| ANSI Ballast Code: | M90/M140 | M102/M142 |
| | 100PSMH120 | 150PSMH120 |
| | 100PSMH208 | 150PSMH208 |
| | 100PSMH240 | 150PSMH240 |
| | 100PSMH277 | 150PSMH277 |
| | 100PSMH347 | 150PSMH347 |
| | 100PSMH480 | 150PSMH480 |

HIGH PRESSURE SODIUM

| | |
|------------|------------|
| E17 | E17 |
| E26 Medium | E26 Medium |
| S54 | S55 |
| 100HPS120 | 150HPS120 |
| 100HPS208 | 150HPS208 |
| 100HPS240 | 150HPS240 |
| 100HPS277 | 150HPS277 |
| 100HPS347 | 150HPS347 |
| 100HPS480 | 150HPS480 |



OPTICAL PACKAGE

CLEAR DROP POLYCARBONATE LENS — Molded clear U.V. stabilized polycarbonate drop lens, sealed with a closed-cell neoprene gasket. Spun aluminum bowl reflector with highly reflective, non-glare white polyester powder coat.

OPAL BULLET LENS — One-piece bullet-shaped U.V. stabilized opal acrylic lens.

OPAL BULLET LENS AND POLISHED ALUMINUM RINGS — One-piece bullet-shaped U.V. stabilized opal acrylic lens. Three evenly-spaced, .375" thick polished aluminum rings.

OPTICAL PACKAGE (Must specify)

CLEAR DROP POLYCARBONATE LENS

DPL Clear drop polycarbonate lens



OPAL BULLET LENS

OBL Opal bullet lens



OPAL BULLET LENS AND POLISHED ALUMINUM RINGS

OBR/PA Opal bullet lens and polished aluminum rings

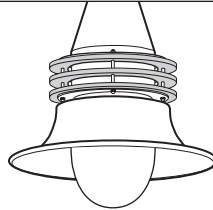

FINISH OPTIONS (Must specify)

BLK Black (RAL #9004)
DBR Dark bronze (Protech #PC21462)
GRAY Standard gray (Protech #PC18367)
GRN Green (RAL #6005)
SLV Satin aluminum (RAL #9006)
WHT White (RAL #9003)
RAL#_____ Specify custom color

FINISH OPTIONS

Super durable polyester powder coat meets and exceeds AAMA 2604 specifications for outdoor durability.

MOUNTING

Williams' exclusive self-leveling twist-lock fitter must be mounted to Williams' standard (TL2) twist-lock hub (see Williams' Decorative Pole Top Assemblies).

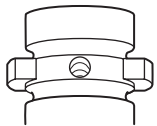

STANDARD TWIST-LOCK FITTER (Fits TL2 hub)

OPTIONS

SF Single fuse (120V, 277V, or 347V only; must specify voltage) **DF** Double fuse (208V, 240V, or 480V only; must specify voltage)

DISTRIBUTION

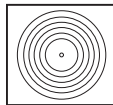

Type V

LABELS

cCSAus certified as luminaire suitable for wet locations.

